

**170094 Dimensions**

Overall Width w/ Trim: 20-5/16"  
(Rough Opening: 18-1/16")

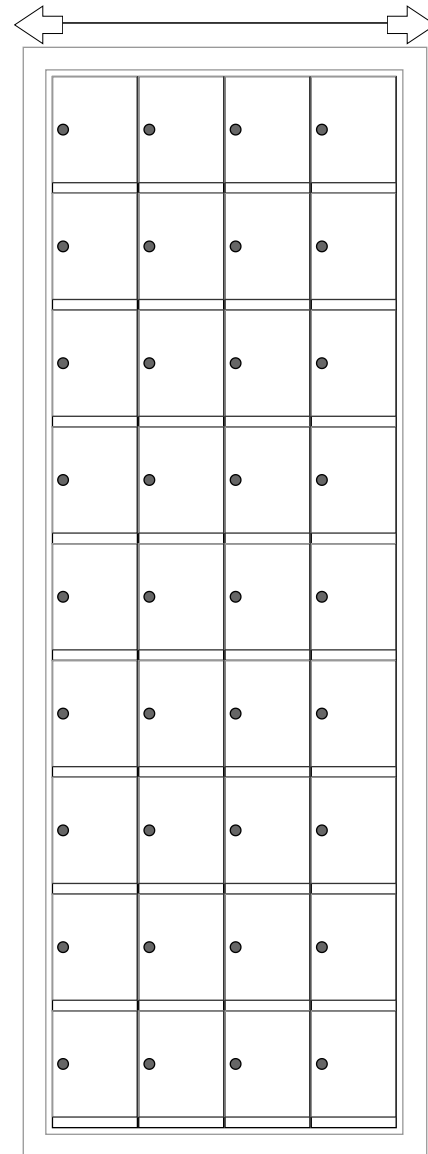

170094

**Side View**

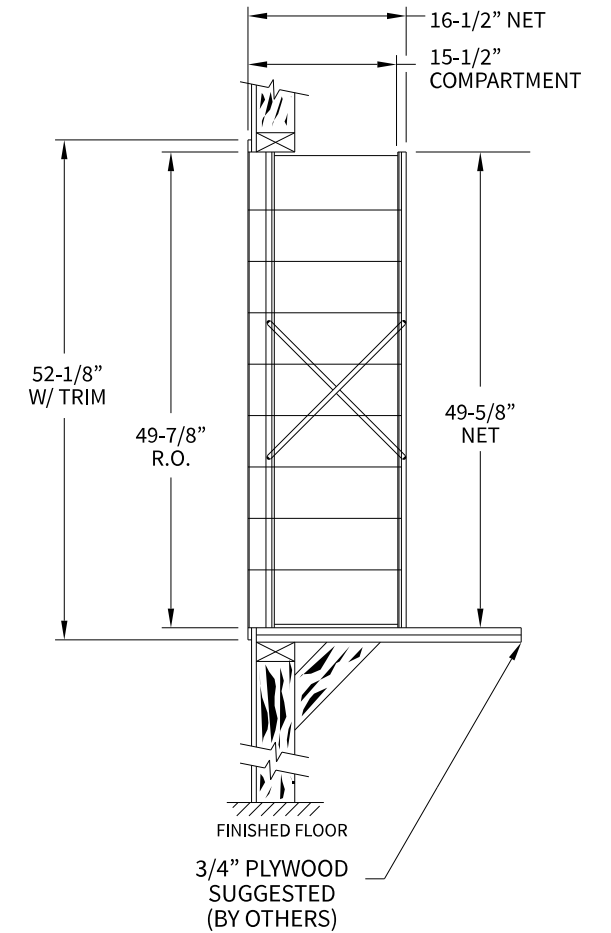

**Configuration Details:**

- 1. **Product Type:** 1700 Horizontal
- 2. **Installation:** Rear-load, Recessed Mount
- 3. **Finish:** Anodized Aluminum
- 4. **Locks:** Standard Cam Lock, 2 keys
- 5. **Door Id:** tbd
- 6. **Rear Cover:** tbd

Matching standard snap-on trim included

**Models Used:**

(1) 170094

**Door Sizes Used:**

(36) 1700 1x1 Compartment

**U.S. MAIL SUPPLY**  
America's Mailbox Headquarters

262-782-6510 Toll Free: 800-571-0147

1553 E. Racine Ave. Waukesha, WI 53186

**ELEVATION:** 170094 | **MAILBOXES:** 36 |

**PROJECT NAME:** 1700 Series Mailbox | **DRAWN BY:** FLORENCE

 5935 Corporate Drive • Manhattan, KS 66503 www.florencemailboxes.com • 800.275.1747 A GIBRALTAR INDUSTRIES COMPANY	<b>DATE:</b> 01-15-2016	<b>P.O. NO:</b>
	<b>SCALE:</b> NONE	<b>QUOTE NO:</b>
	<b>DRAWING NO.</b> WEB-1932	<b>SHEET 1 OF 1</b>