

140074D Dimensions

Overall Width w/ Trim: 29-3/4"
(Rough Opening: 27-1/2")

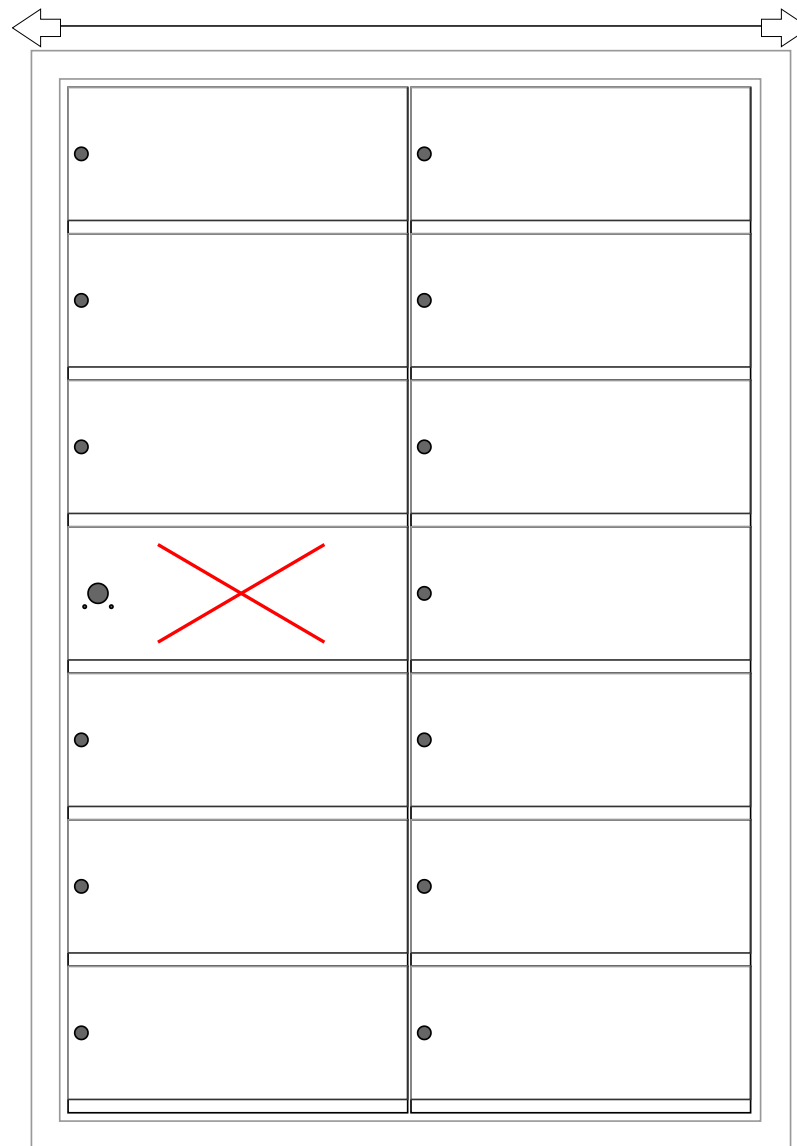

140074D

Side View

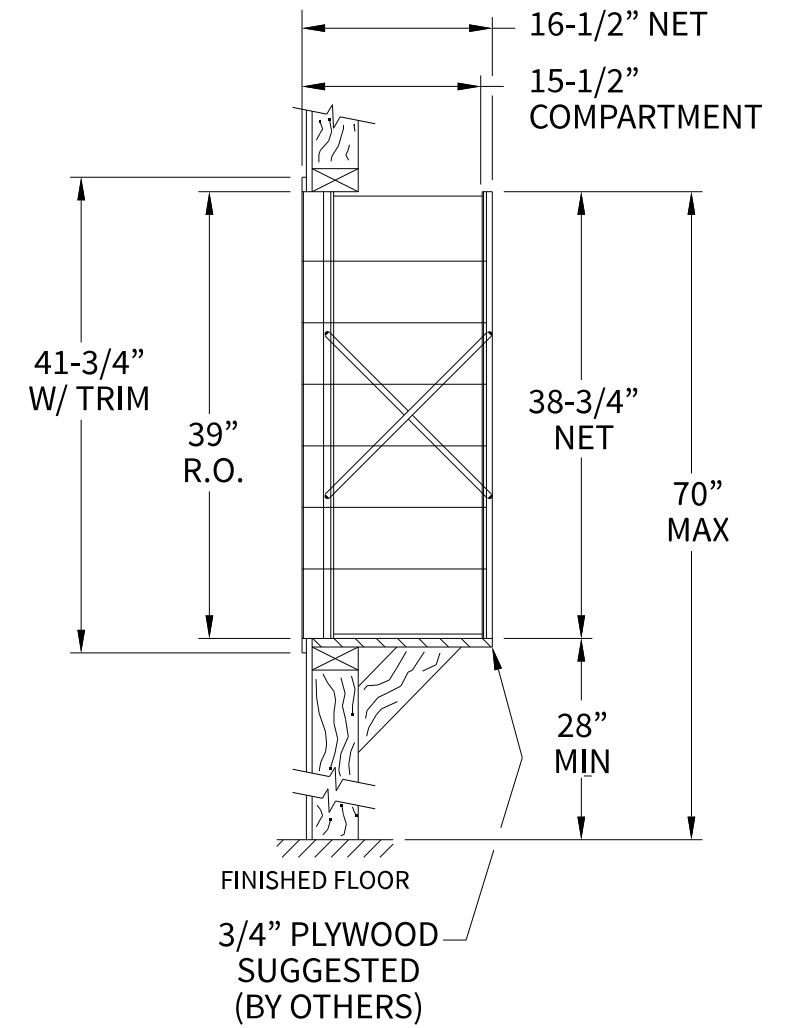

Configuration Details:

- 1. **Product Type:** 1400 Horizontal
- 2. **Installation:** Front-load, Recessed Mount
- 3. **Finish:** Anodized Aluminum
- 4. **Locks:** Standard Cam Lock, 2 keys
- 5. **Door Id:** tbd
- 6. **Master Door:** tbd

Matching standard snap-on trim included

Models Used:

(1) 140074D

Door Sizes Used:

(1) 1x2 Master
(13) 1403 1x2 Compartment

U.S. MAIL SUPPLY
America's Mailbox Headquarters

262-782-6510 Toll Free: 800-571-0147

1553 E. Racine Ave. Waukesha, WI 53186

ELEVATION: 140074D | **MAILBOXES:** 13 |

PROJECT NAME: 1400 Series Mailbox | **DRAWN BY:** FLORENCE

 5935 Corporate Drive • Manhattan, KS 66503 www.florencemailboxes.com • 800.275.1747 A GIBRALTAR INDUSTRIES COMPANY	DATE: 01-15-2016	P.O. NO:
	SCALE: NONE	QUOTE NO:
	DRAWING NO. WEB-1934	SHEET 1 OF 1