

1400-75PL Dimensions

Overall Width w/ Trim: 36-1/8"
(Rough Opening: 33-7/8")

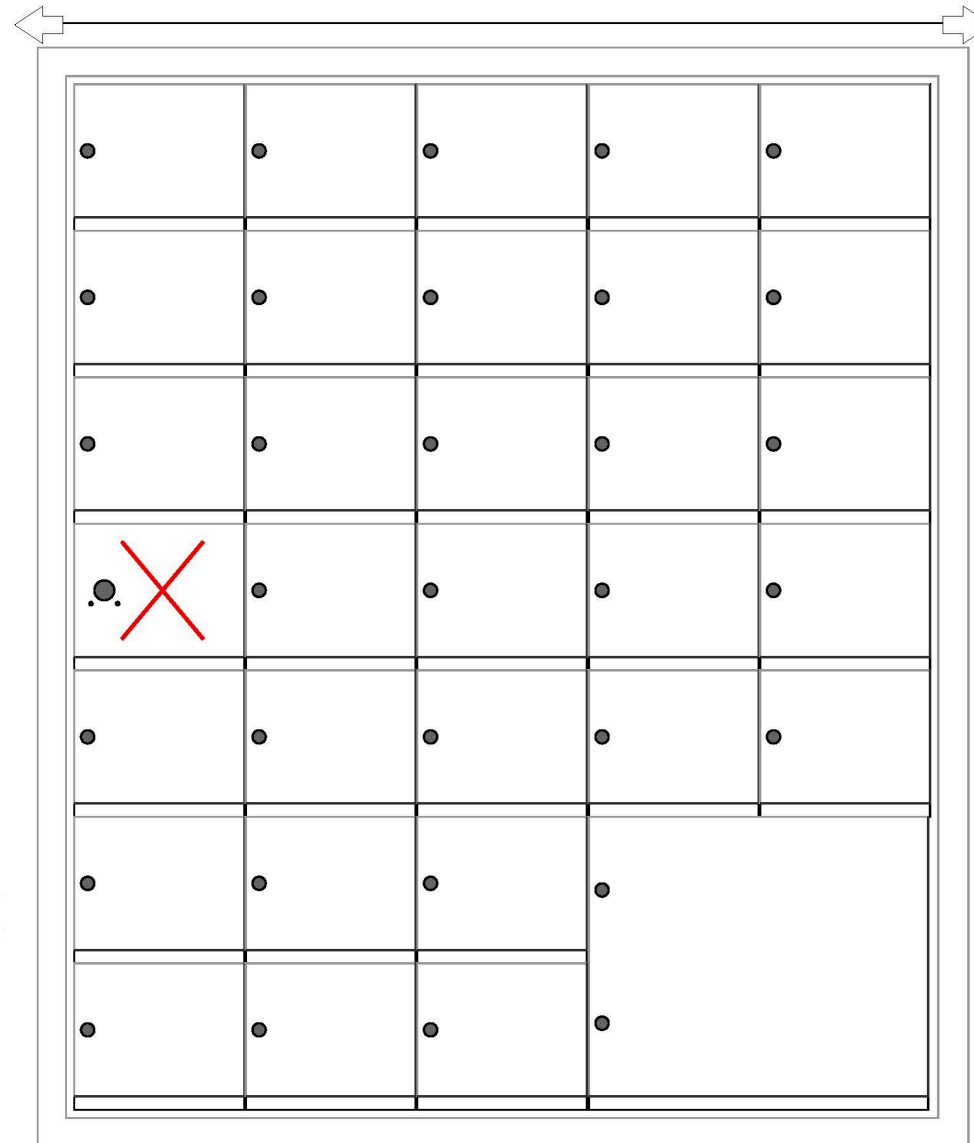

140075PL

Side View

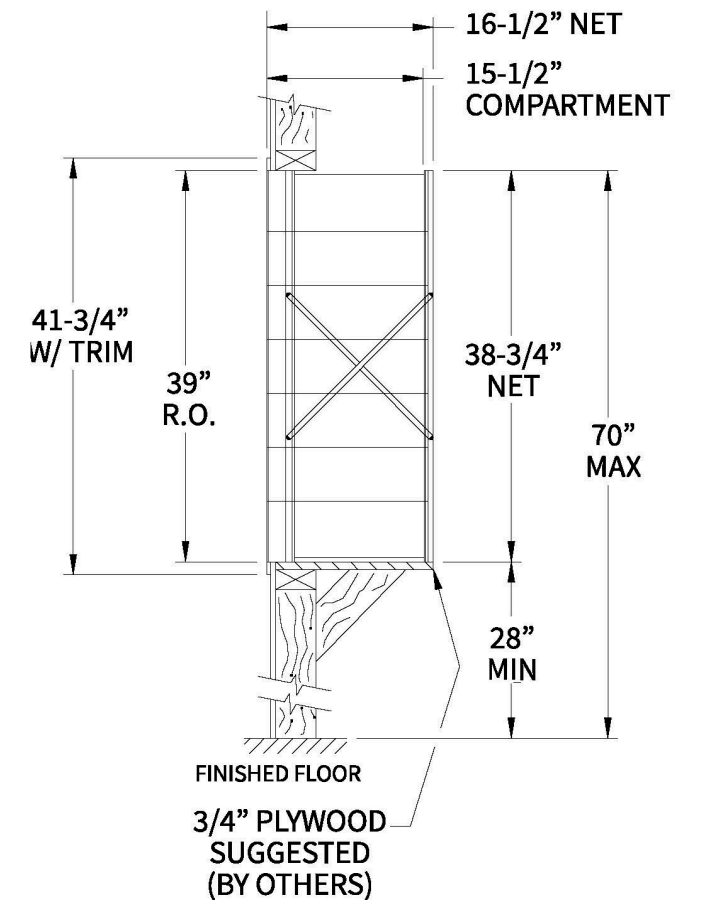

This Product Distributed By:
U.S. Mail Supply, Inc.
 3065 North 124th Street
 Brookfield, WI 53005-3857
 Ph: 800-571-0147 / Fax: 800-589-1068
 www.usmailsupply.com

Configuration Details:

1. **Product Type:** 1400 Horizontal
2. **Installation:** Front-load, Recessed Mount
3. **Finish:** tbd
4. **Locks:** tbd
5. **Door Id:** tbd

Matching standard snap-on trim included

Models Used:

(1) 140075PL

DO NOT SCALE OFF DRAWING

Door Sizes Used:

- (30) 1400 1x1 Compartment
- (1) 1x1 Master
- (1) 1404 2x2 Parcel

ELEVATION: 1400-75PL | **MAILBOXES:** 30 | **PARCELS:** 1 |

DEALER: U.S. MAIL SUPPLY, INC.

PROJECT NAME: 1400 SERIES

DRAWN BY:

AF FLORENCE
 manufacturing company

5935 Corporate Drive • Manhattan, KS 66503
 www.florencemailboxes.com • 800.275.1747

A GIBALTAR INDUSTRIES COMPANY

DATE: 01-29-2016

P.O. NO:

SCALE: NONE

QUOTE NO:

DRAWING NO. WEB-24509

SHEET 4 OF 5